

# INSTALLATION MANUAL

10122D

**ecolight**



CE

RoHS  
COMPLIANT



NOT  
DIMMABLE

80  
CRI

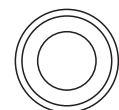

175mm

230V | SMD 2835 | 22W | IP20 | Die cast  
Complete with 500mA driver.

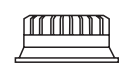
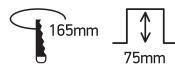
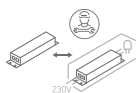

55mm

**one**  
LIGHT

**A**

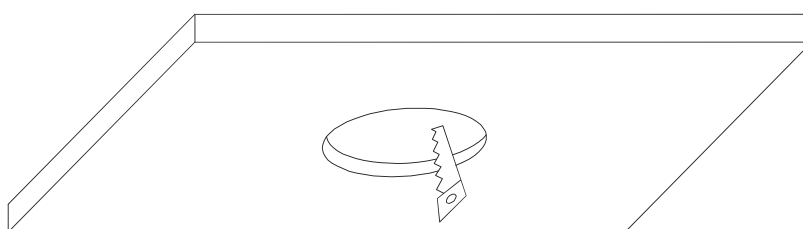

CUTOUT HOLE: 165mm

**B**

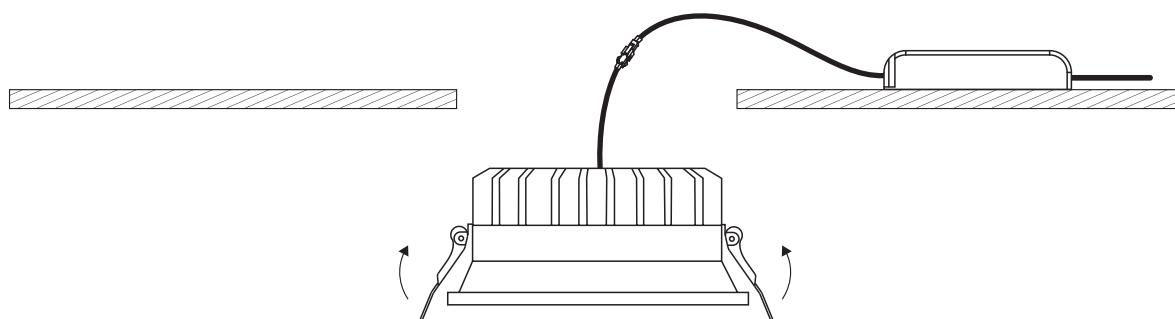

**C**

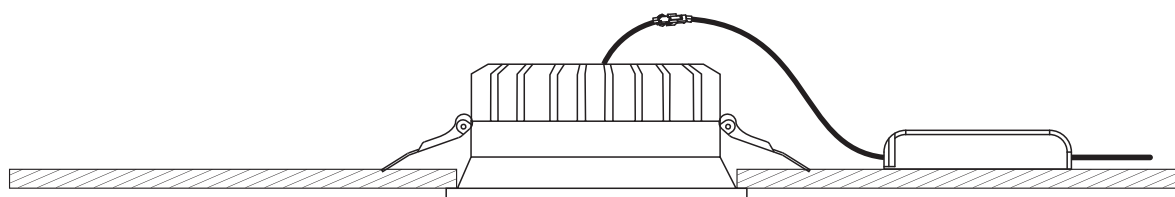

\*IP54 is the protection degree of the fitting under the ceiling. The fitting part hidden in the ceiling is IP20

## Warnings:

1. Make sure that the product is installed properly before connecting to electricity.
2. Do not cover the fitting.
3. Maintenance and installation should only be carried out by a professional electrician.